

# 温度保险丝

Thermal-Link (ATCO)

B系列 Series



## 应用 Applications

- 灯具 Lamps
- 开关电源 Switched-Mode Power Supplies
- 家用电器 Home Electrical Appliances
- 变压器 Transformers
- 电机 Motors
- 电热毯 Electric Blankets
- 香薰器 Electric Aroma Diffusers

## 特性 Features

- 动作温度精确 High Accuracy of Functioning Temp.
- 一次性动作而不可复位 Non-Resettable
- 环保型产品 RoHS & REACH Compliant

## 定制 Customization

- 温度 Temp.
- 引线长度 The Length of Lead Wires
- 可编带包装 Taping Packing Available
- 引线可采用绝缘线 Lead Wires can be Insulated
- 引线材质可选镀锡铜线或CP线 Tinned Copper Wires or CP Wires

## 安规认证 Agency Approvals

安规 Agency Mark	标准 Standards	认证号 No.
	UL 60691	E214712
	CAN-CSA-E60691	E214712
	EN 60691	R50259434
	J60691	PSE15020870、PSE15020871 PSE15020872、PSE15020873 PSE15020874、PSE15020875 PSE15020876
	K60691	SU05023-11001、SU05023-11002 SU05023-11003
	GB 9816.1	2020980205000186

## 尺寸 Dimensions (mm)

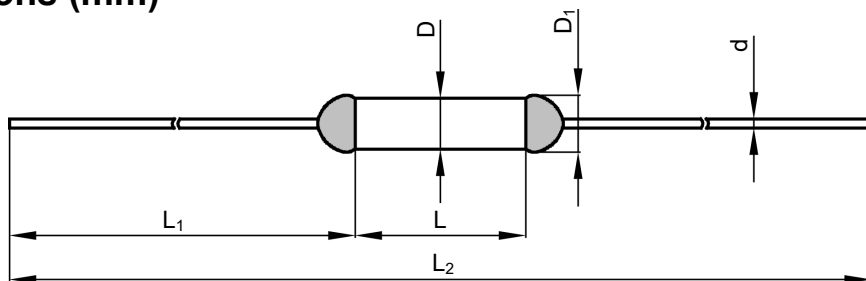





L	L <sub>1</sub>	L <sub>2</sub>	D	D <sub>1</sub>	d
10.0 ± 0.5	35.0 ± 2.0	80.0 ± 3.0	3.0 ± 0.5	≤ 3.5	0.54 ± 0.05

ATCO

ATCO

技术参数 Specifications

型号 Model	额定动作 温度 $T_f$	熔断温度 Fusing Temp.	保持温度 $T_h$	极限温度 $T_m$	额定电流 $I_r$	额定电压 $U_r$							RoHS REACH			
	(°C)	(°C)	(°C)	(°C)	(A)	(V)	UL	cUL	TUV	PSE	KTL	CCC				
B0	76	73 ± 2	53	200	3	AC 250	○	○	●	●	●	●	●			
						AC 125	●	●	○	○	○	○	○	○	○	○
						DC 50	●	●	○	○	○	○	○	○	○	○
B18	86	81 ± 2	61	200	3	AC 250	○	○	●	●	●	●	●			
						AC 125	●	●	○	○	○	○	○	○	○	
						DC 50	●	●	○	○	○	○	○	○	○	
B21	97	93 ± 2	70	200	3	AC 250	○	○	○	○	○	○	○			
						AC 125	●	●	○	○	○	○	○	○	○	
						DC 50	●	●	○	○	○	○	○	○	○	
B1	102	98 ± 3	79	200	3	AC 250	○	○	●	●	●	●	●			
						AC 125	●	●	○	○	○	○	○	○	○	
						DC 50	●	●	○	○	○	○	○	○	○	
B2	115	111 ± 2	91	200	3	AC 250	●	●	●	●	●	●	●			
						DC 50	●	●	○	○	○	○	○	○	○	
B3	125	121 ± 2	100	200	3	AC 250	●	●	●	●	●	●	●			
						DC 50	●	●	○	○	○	○	○	○	○	
B4	130	125 ± 2	106	200	3	AC 250	●	●	●	●	●	●	●			
						DC 50	●	●	○	○	○	○	○	○	○	
B8	133	130 ± 2	111	200	3	AC 250	●	●	●	●	●	●	●			
						DC 50	●	●	○	○	○	○	○	○	○	
B5	135	130 ± 2	111	200	3	AC 250	●	●	●	●	●	●	●			
						DC 50	●	●	○	○	○	○	○	○	○	
B9	136	131 ± 2	112	200	3	AC 250	●	●	●	●	●	●	●			
						DC 50	●	●	○	○	○	○	○	○	○	
B13	139	135 ± 2	115	200	3	AC 250	●	●	●	●	●	●	●			
						DC 50	●	●	○	○	○	○	○	○	○	
B6	145	140 ± 2	121	200	3	AC 250	●	●	●	●	●	●	●			
						DC 50	●	●	○	○	○	○	○	○	○	
B7	150	145 ± 2	126	200	3	AC 250	●	●	●	●	●	●	●			
						DC 50	●	●	○	○	○	○	○	○	○	
B16	160	154 ± 2	135	200	3	AC 250	○	○	●	●	○	●	●			
						DC 60	○	○	●	○	○	○	○	○	○	
B32	205	199 ± 3	169	250	3	AC 250	○	○	●	●	○	●	●			
						AC 125	●	●	○	○	○	○	○	○	○	
						DC 60	●	●	●	○	○	○	○	○	○	
B31	221	218 ± 2	188	250	3	AC 250	●	●	●	●	○	●	●			
						AC 125	●	●	○	○	○	○	○	○	○	
						DC 60	●	●	●	○	○	○	○	○	○	

备注 Note:

"●"表示产品已通过认证。Means certificated.

"○"表示产品未有认证。Means non-certificated.

产品温度时间曲线图 (仅供参考)  
Product Temp.-Time Curve (For Reference Only)

温度保险丝在不同温度油浴中断开的温度时间曲线。  
The Temp.-Time Curve of Thermal-Link in different Temp. oil baths.

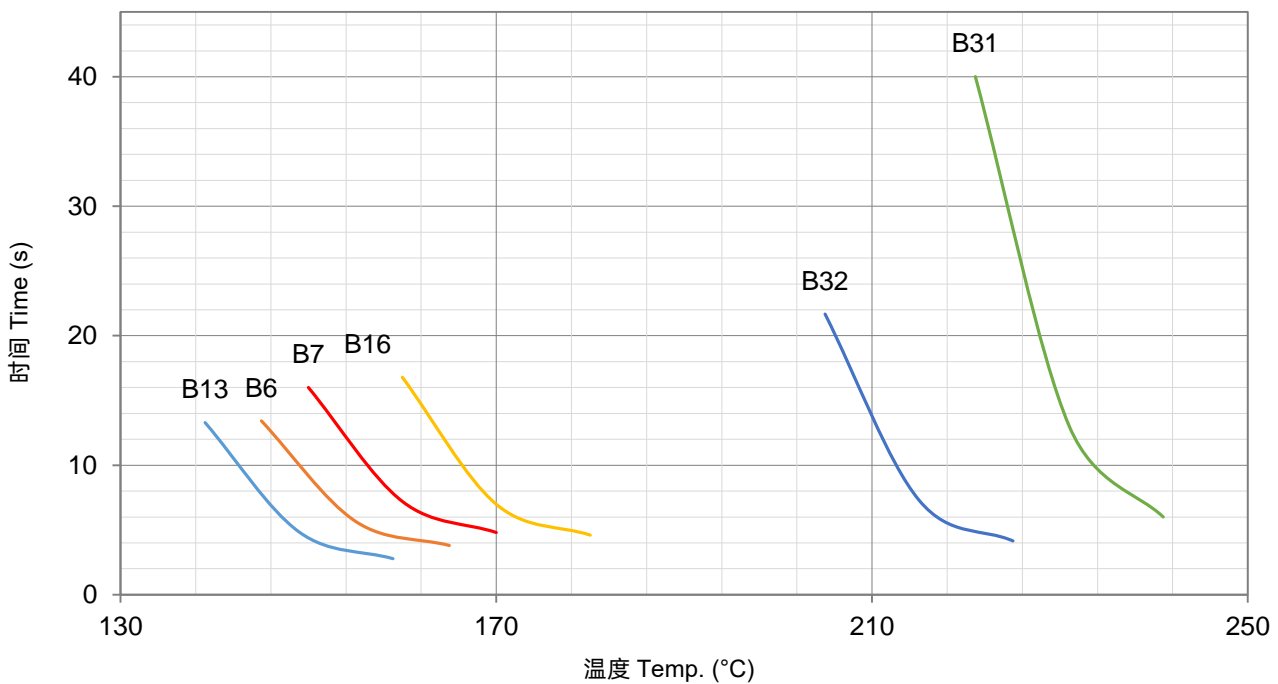
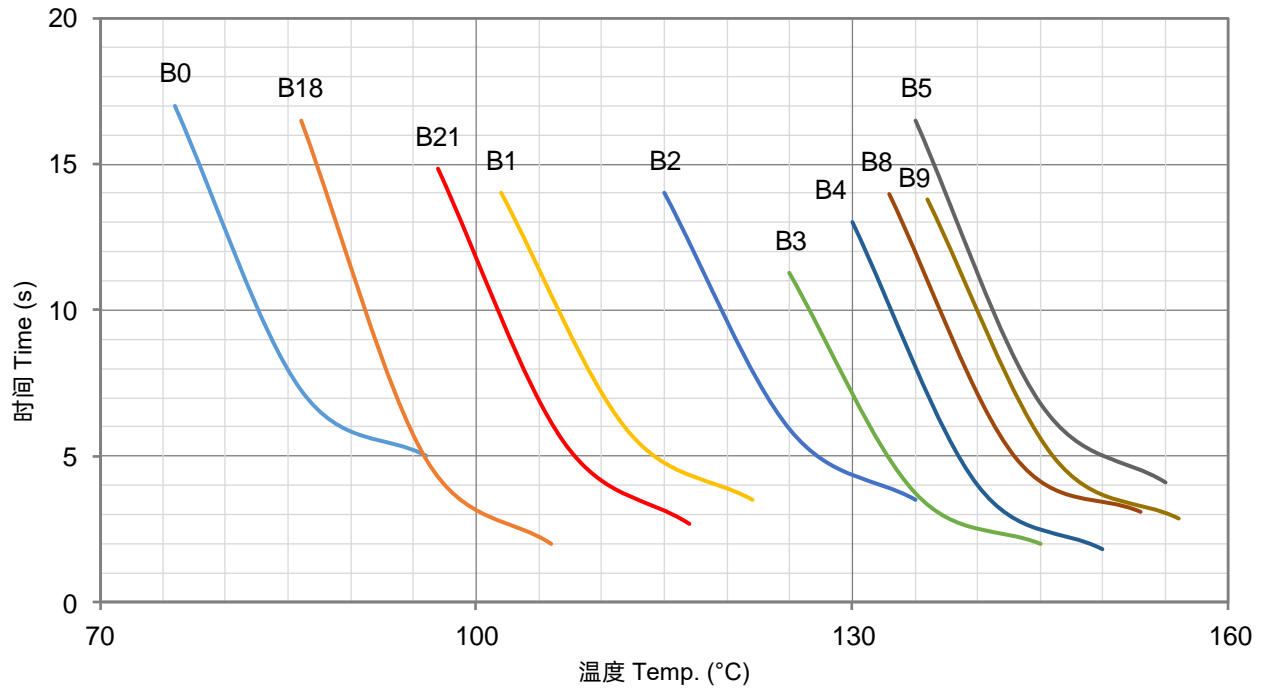

产品电流时间曲线图 (仅供参考)  
Product Current-Time Curve (For Reference Only)

温度保险丝在室温 $25 \pm 2 \text{ }^\circ\text{C}$ 条件下, 测试数倍过载电流下的断开时间曲线。  
The Current-Time Curve shows functioning time at multi-times rated current at room temperature  $25 \pm 2 \text{ }^\circ\text{C}$ .

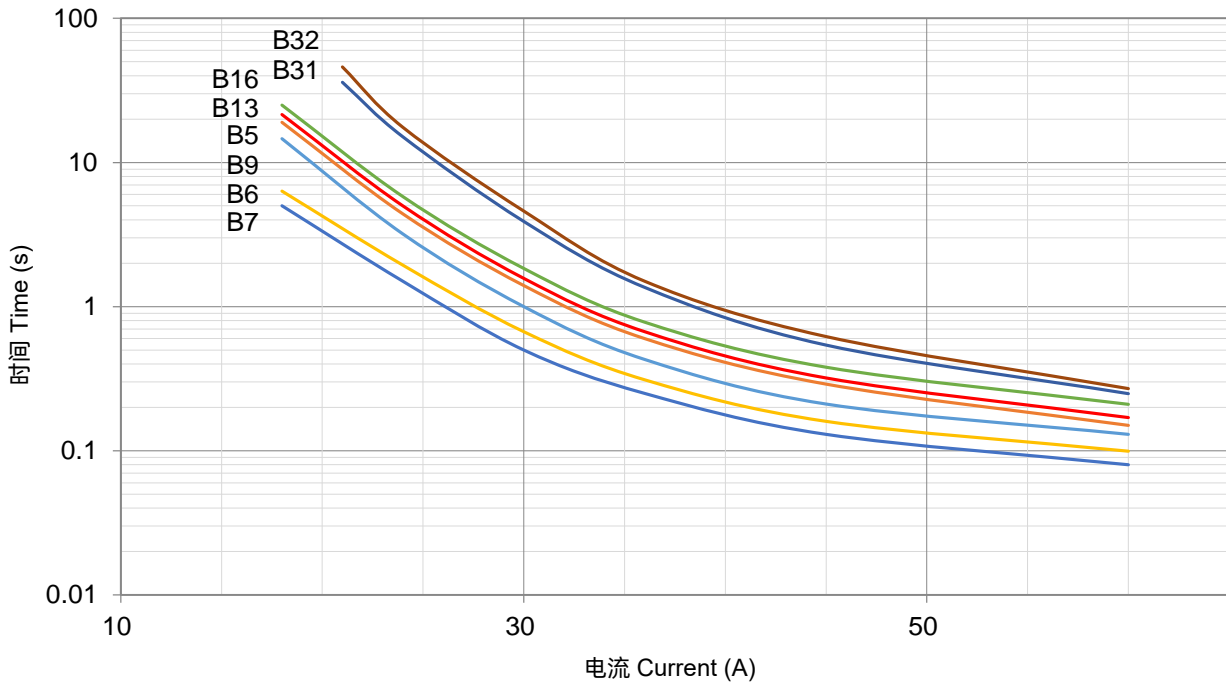
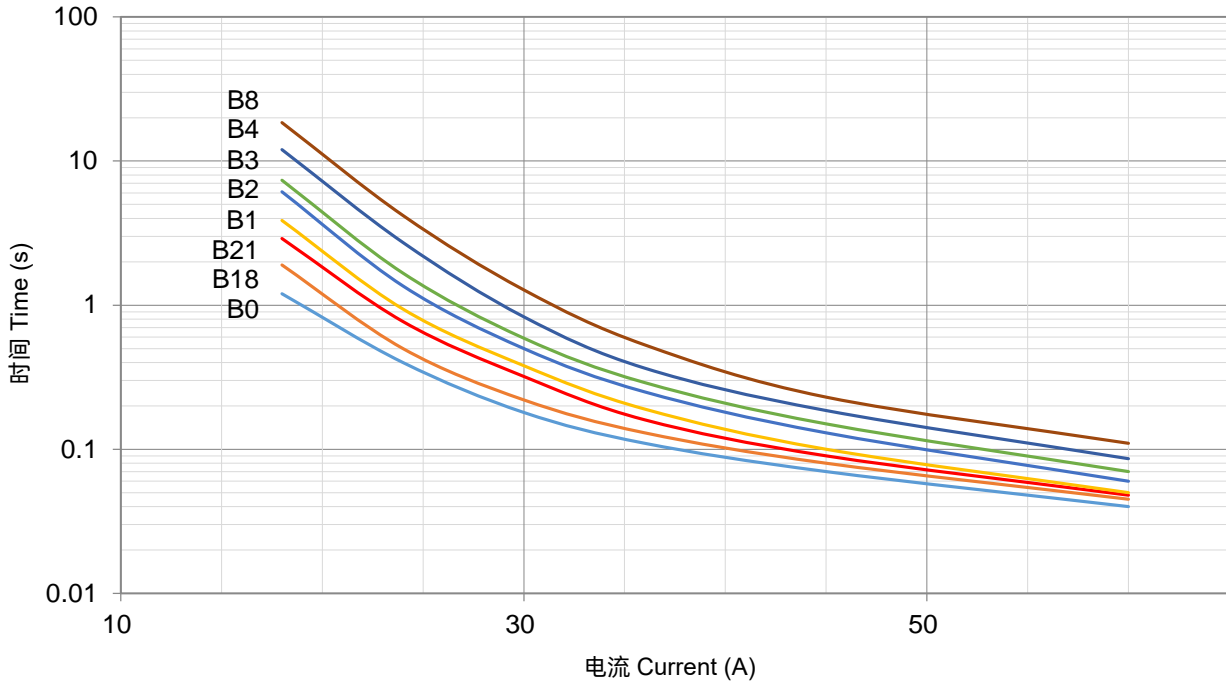

# 温度保险丝

Thermal-Link (ATCO)

B系列 Series

## 包装信息 Packaging Information

散装 Bulk

项目 Item	PE 袋 Bag	PE 袋 Bag	包装箱 Carton
尺寸 Dimensions (mm)	135 × 85	190 × 180	440 × 300 × 260
数量 Quantity (PCS)	100	1000	40000
毛重 Gross Weight (kg)			15.0 ± 10%

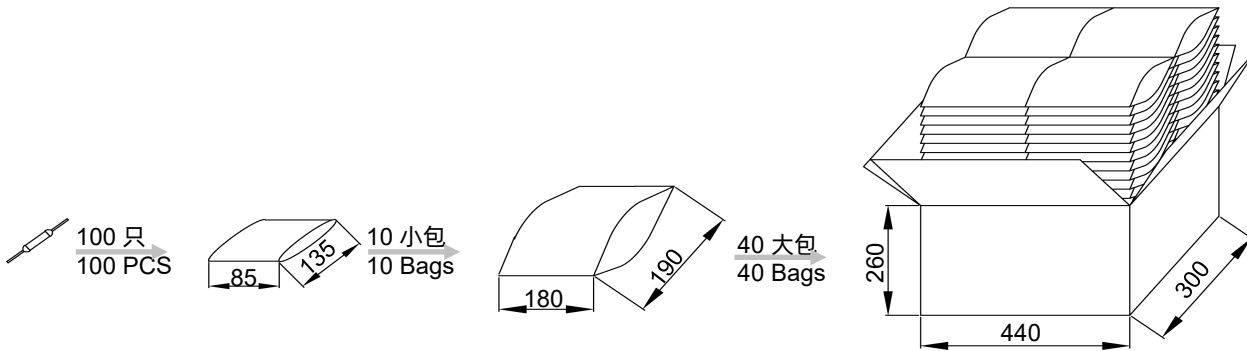

编带 Taping

项目 Item	卷轴 Scroll	盒子 Box	包装箱 Carton
尺寸 Dimensions (mm)	Φ 250 × 94	258 × 258 × 98	480 × 300 × 260
数量 Quantity (PCS)	2500	2500	10000
毛重 Gross Weight (kg)			5.6 ± 10%

